

+ 4%

# COMPACT SINK DA INCASSO

BULIT IN COMPACT SINK

**GIERREDUE**

surfaces | design

La nuova declinazione del lavello da incasso secondo GIERREDUE. Una collezione di forme, dimensioni e finiture per abbinarsi al piano di lavoro o per creare nuovi contrasti per rendere unico ogni progetto.





Lavello Mod. Vento con  
gocciolatoio in finitura Calacatta

Lavello Mod. Ideal  
finitura Bardiglio  
con fondo in acciaio inox  
finitura Vintage





Lavello Mod. Simpli  
con fondo in HPL e gocciolatoio  
scorrevole in appoggio (accessorio)  
finitura Testa di Moro





Lavello con gocciolatoio  
Mod. Vento  
finitura Quercia  
e fondo in acciaio inox  
finitura PVD bronzo





Lavello Mod. Stop in  
finitura ossido con fondo  
in HPL e predisposizione  
per foro miscelatore  
integrato



Lavello Mod Brezza  
con fondo in acciaio inox  
finitura Zebra Nero (a sx)  
finitura PVD Titanio (in alto)







## SOMMARIO

Condizioni generali di vendita.....	pag.	12
Finiture FASCIA 1.....	pag	13
Finiture FASCIA 3 e Finiture FASCIA 4.....	pag	14
Sink Compact Mod. SIMPLI .....	pag.	15
Sink Compact Mod. SINTONIA.....	pag.	16
Sink Compact Mod. IDEAL.....	pag.	17
Sink Compact Mod. STOP .....	pag.	18
Sink Compact Mod. BREZZA .....	pag.	19
Sink Compact Mod. START.....	pag.	20
Sink Compact Mod. LINE.....	pag.	21
Sink Compact Mod. SILVER .....	pag.	22
Sink Compact Mod. VENTO Scivolo.....	pag.	23
Sink Compact Mod. SLITTA Scivolo .....	pag.	24
Sink Compact Mod. FONTANA Scivolo .....	pag.	25
Sink Compact Mod. FUGGI Scivolo.....	pag.	26
Sink Compact Mod. PIAZZA Scivolo.....	pag.	27
Sink Compact Mod. ARTE Scivolo .....	pag.	28
Sink Compact Mod. RIBA Scivolo .....	pag.	29
Sink Compact Mod. LUNA Scivolo .....	pag.	30
Sgocciolatoio e Tagliere Coprivasca scorrevoli .....	pag.	31
Sommario Categorie.....	pag.	32
Note .....	pag.	33

## CONDIZIONI GENERALI DI VENDITA

**Prezzi:** i prezzi indicati si intendono al pubblico IVA esclusa ed espressi in Euro. Eventuali prezzi non indicati verranno comunicati su specifica richiesta di preventivo.

**Trasporto: I prezzi sono esclusi di trasporto . Applicare il 5% dell'importo (minimo fatturabile € 42,00). Supplemento vasca € 15,75.**

**Misure:** GR2 Arredamenti non si ritiene responsabile per eventuali errori di comunicazione relativi alle lavorazioni da eseguire facendo fede le "conferme d'ordine" inviate per verifica.

**Riserva per danni:** Il cliente ha l'obbligo di controllare la merce al momento dello scarico. Se l'imballo risultasse danneggiato occorre segnalarlo sui documenti di trasporto, entrambe le copie, con la dicitura "Ritiro con riserva imballo danneggiato". Il controllo della merce deve essere comunque effettuato entro 3 giorni dalla consegna e, nel caso di danni riscontrati, esiste l'obbligo di comunicazione al Produttore entro 7 giorni dal ricevimento della merce. Non sono ammesse pretese che superino l'importo della fattura relativa al prodotto danneggiato. In caso di reclamo giustificato per non conformità attribuibili al Fabbricante viene concesso esclusivamente il ripristino, ove possibile o la sostituzione gratuita del bene. Niente altro potrà essere preteso.

**Lavorazioni:** Gli sfridi di lavorazione sono proprietà del Fabbricante.

**Ordini:** L'ordine si intende esecutivo al momento della ricezione della relativa "conferma d'ordine" de-

bitamente sottoscritta per accettazione. Eventuali variazioni che intervengano successivamente dovranno essere verificate ed approvate dal Produttore. I costi delle modifiche e delle prestazioni già fornite in caso di correzioni e annullamenti sono a carico del Committente. Non si accettano ordini se non in forma scritta.

**Resi di merce:** Non si accettano resi di merce se non espressamente autorizzati per iscritto.

**Immagini:** Immagini e descrizioni non sono vincolanti ed hanno puramente funzione illustrativa.

**Termini di consegna:** I termini di consegna indicati in "conferma d'ordine" saranno osservati nei limiti del possibile. In caso di ritardo non possono farsi valere pretese di indennizzo di alcun tipo.

**Riserva di proprietà:** La merce inviata rimane di proprietà del Fabbricante fino al saldo dell'intero importo dovuto e, in difetto, GR2 Arredamenti si riserva il diritto di pretendere la restituzione in qualsiasi momento

**Foro di competenza:** Per qualsiasi controversia il Foro competente nominato è il Foro di Siena.

**Campionario e finiture:** L'azienda si riserva di modificare il proprio campionario finiture in ogni momento in base all'andamento del mercato e alla disponibilità della finitura.

**Prodotti:** GR2 Arredamenti si riserva di modificare, a proprio avviso, i prodotti oggetto del presente listino per ragioni tecniche o commerciali, dandone opportuna comunicazione.

## Fascia 1 • FINITURE STRATIFICATO CUORE NERO PER LAVELLI



GESO 410 CLIMB  
misura max pannello 420x130 cm



TESTA DI MORO  
misura max pannello 420x130 cm



RESINA CLIMB 1452  
misura max pannello 420x130 cm



LAVAGNA  
misura max pannello 420x130 cm



RUGGINE  
misura max pannello 420x130 cm



PIETRA SERENA 1450  
misura max pannello 420x130 cm



ALABASTRO GREY  
misura max pannello 420x130 cm



VINTAGE FUMÉ  
misura max pannello 420x130 cm



OSSIDO 545  
misura max pannello 420x130 cm



ARGILLA  
misura max pannello 420x130 cm



ORIENTAL 5563  
misura max pannello 420x130 cm



DARK  
misura max pannello 420x130 cm



OXUN  
misura max pannello 420x130 cm



BARDIGLIO  
misura max pannello 420x130 cm



ROVERE ANTICO  
misura max pannello 420x130 cm



QUERCIA  
misura max pannello 420x130 cm



CARBONE TAVOLATO  
misura max pannello 420x130 cm



GRIGIO CEMENTO 2810 CLIMB  
misura max pannello 420x130 cm



TRAVERTINO 547 CLIMB  
misura max pannello 420x130 cm

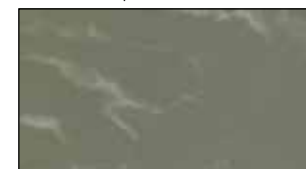

PERLATO  
misura max pannello 420x130 cm

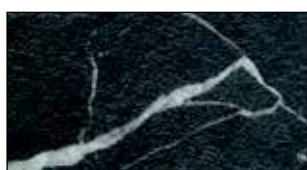

ZEBRA NERO  
misura max pannello 420x130 cm



NERO STREET  
misura max pannello 420x130 cm

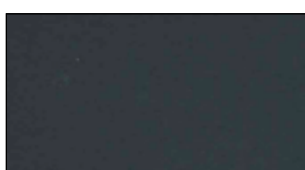

CENERE  
misura max pannello 420x130 cm



LAMIERA  
misura max pannello 360x130 cm



POLVERE  
misura max pannello 360x130 cm



KANDIA  
misura max pannello 420x130 cm

**NOTA:** Misura max top mm. 418x128 - I colori sono indicativi. Verificare i campioni

## Fascia 3 • FINITURE STRATIFICATO CUORE COLORE PER LAVELLI

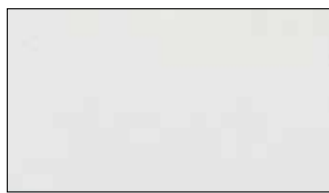

EXTRA BIANCO  
misura max pannello 420x130 cm



TRAVERTINO 547 CLIMB  
misura max pannello 420x130 cm



GESSO 410 CLIMB  
misura max pannello 420x130 cm



CALACATTA  
misura max pannello 420x130 cm

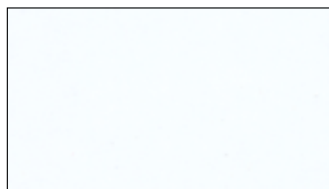

BIANCO GHIACCIO 399  
misura max pannello 420x130 cm



ARGILLA  
misura max pannello 420x130 cm

## Fascia 4 • FINITURE STRATIFICATO FENIX CUORE NERO PER LAVELLI

### FENIX

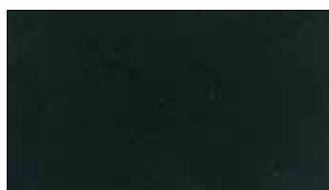

NERO INGO  
misura max pannello 420x130 cm

**NOTA:** Misura max top mm. 418x128  
I colori sono indicativi. Verificare i campioni

## LAVELLI DA INCASSO

### ACCESSORI SINK COMPACT DA INCASSO (di serie)



PILETTA  
BASKET  
TONDA

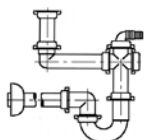

SIFONE

PILETTA BASKET TONDA	54,24
SIFONE 1 VASCA	14,14

# SINK COMPACT MOD. SIMPLI INTERCAMBIABILE P. 210 mm

## FONDO HPL - COSTRUITA IN HPL

### PER BASE 60

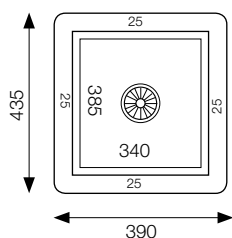

FASCIA 1	€	517,36
PILETTA BASKET	€	54,24
SIFONE	€	14,14
<b>Totale</b>	€	<b>585,75</b>

### PER BASE 60

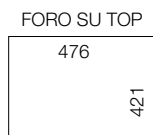
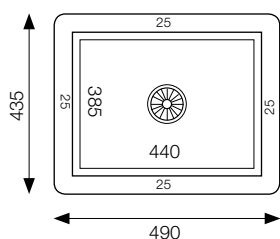

FASCIA 1	€	554,30
PILETTA BASKET	€	54,24
SIFONE	€	14,14
<b>Totale</b>	€	<b>622,68</b>

### PER BASE 80

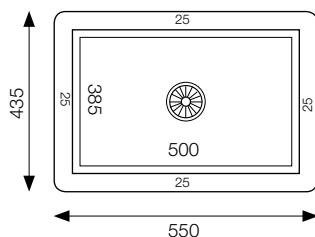

FASCIA 1	€	608,90
PILETTA BASKET	€	54,24
SIFONE	€	14,14
<b>Totale</b>	€	<b>677,29</b>

### PER BASE 90

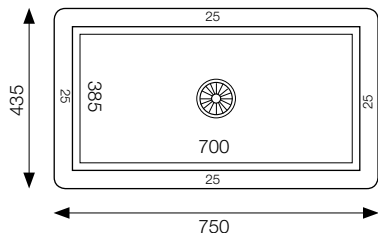

FASCIA 1	€	626,01
PILETTA BASKET	€	54,24
SIFONE	€	14,14
<b>Totale</b>	€	<b>694,40</b>

# SINK COMPACT MOD. SINTONIA INTERCAMBIABILE P. 210 mm

## CON FORO RUBINETTO - FONDO HPL - COSTRUITA IN HPL

### PER BASE 60

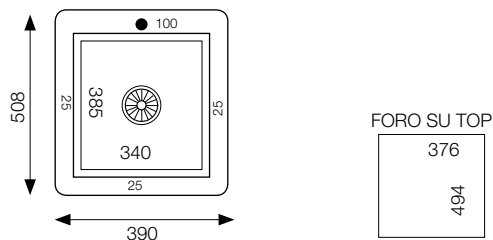

FASCIA 1	€	530,34
PILETTA BASKET	€	54,24
SIFONE	€	14,14
<b>Totale</b>	€	<b>598,73</b>

### PER BASE 60

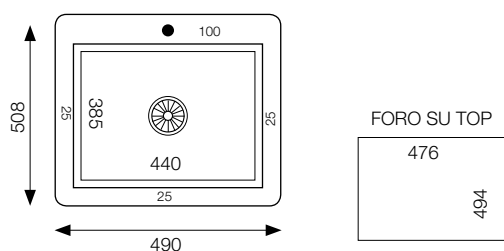

FASCIA 1	€	567,28
PILETTA BASKET	€	54,24
SIFONE	€	14,14
<b>Totale</b>	€	<b>635,67</b>

### PER BASE 80

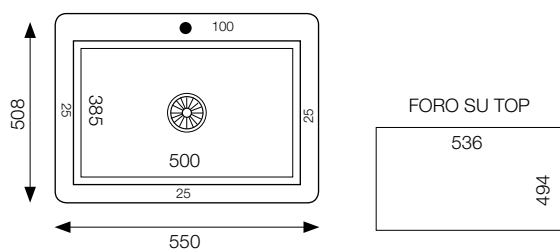

FASCIA 1	€	621,88
PILETTA BASKET	€	54,24
SIFONE	€	14,14
<b>Totale</b>	€	<b>690,27</b>

### PER BASE 90

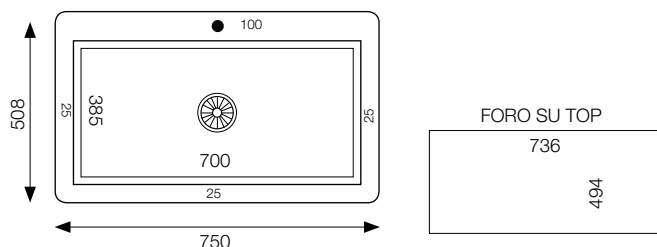

FASCIA 1	€	638,99
PILETTA BASKET	€	54,24
SIFONE	€	14,14
<b>Totale</b>	€	<b>669,58</b>



# SINK COMPACT MOD. IDEAL INTERCAMBIABILE P. 210 mm

**FONDO FILO INOX - COSTRUITA IN HPL**  
**FONDO VINTAGE - COSTRUITA IN HPL**

## PER BASE 60

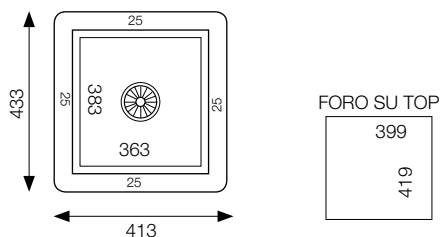

	FONDO FILO INOX	FONDO VINTAGE
FASCIA 1	€ 517,86	€ 569,13
FASCIA 3 / FASCIA 4	€ 517,36	€ 569,13
PILETTA BASKET	€ 54,24	€ 54,24
SIFONE	€ 14,14	€ 14,14
<b>Totale Fascia 1/3/4</b>	<b>€ 585,75</b>	<b>€ 637,51</b>

## PER BASE 60

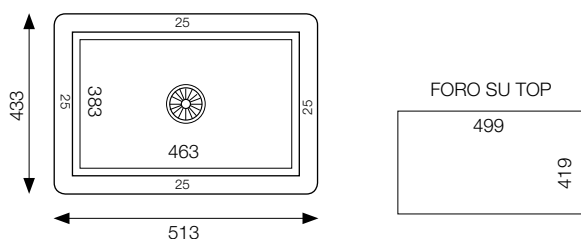

	FONDO FILO INOX	FONDO VINTAGE
FASCIA 1	€ 554,30	€ 609,73
FASCIA 3 / FASCIA 4	€ 554,30	€ 609,73
PILETTA BASKET	€ 54,24	€ 54,24
SIFONE	€ 14,14	€ 14,14
<b>Totale Fascia 1/3/4</b>	<b>€ 622,69</b>	<b>€ 678,12</b>

## PER BASE 80 / 90

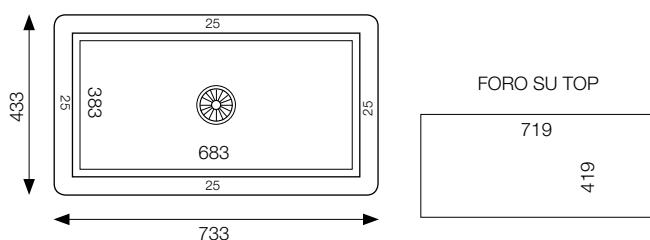

	FONDO FILO INOX	FONDO VINTAGE
FASCIA 1	€ 626,02	€ 688,62
FASCIA 3 / FASCIA 4	€ 626,02	€ 688,62
PILETTA BASKET	€ 54,24	€ 54,24
SIFONE	€ 14,14	€ 14,14
<b>Totale Fascia 1/3/4</b>	<b>€ 694,40</b>	<b>€ 757,00</b>

# SINK COMPACT MOD. STOP INTERCAMBIABILE P. 210 mm

**CON FORO RUBINETTO - FONDO FILO INOX - COSTRUITA IN HPL**  
**CON FORO RUBINETTO - FONDO VINTAGE - COSTRUITA IN HPL**

## PER BASE 60

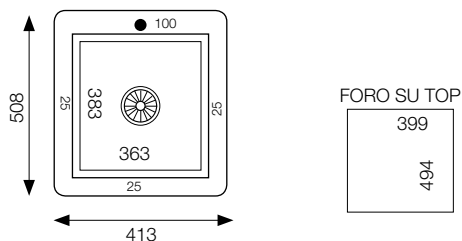

	FONDO FILO INOX	FONDO VINTAGE
FASCIA 1	€ 530,34	€ 583,37
FASCIA 3 / FASCIA 4	€ 530,34	€ 583,37
PILETTA BASKET	€ 54,24	€ 54,24
SIFONE	€ 14,14	€ 14,14
<b>Totale Fascia 1/3/4</b>	<b>€ 598,73</b>	<b>€ 651,75</b>

## PER BASE 60

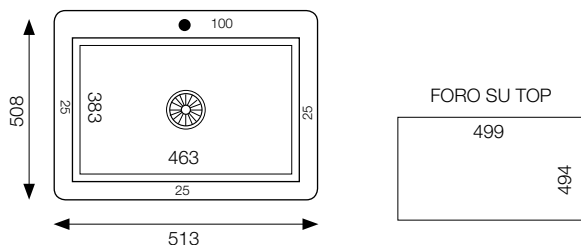

	FONDO FILO INOX	FONDO VINTAGE
FASCIA 1	€ 567,28	€ 624,00
FASCIA 3 / FASCIA 4	€ 567,28	€ 624,00
PILETTA BASKET	€ 54,24	€ 54,24
SIFONE	€ 14,14	€ 14,14
<b>Totale Fascia 1/3/4</b>	<b>€ 635,67</b>	<b>€ 692,39</b>

## PER BASE 80 / 90

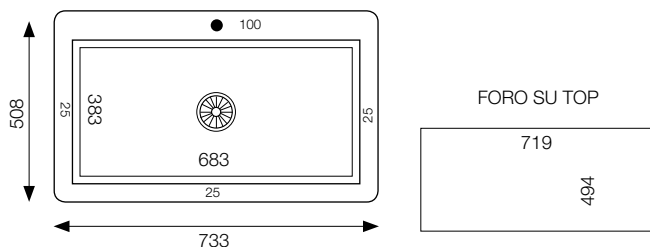

	FONDO FILO INOX	FONDO VINTAGE
FASCIA 1	€ 638,99	€ 702,89
FASCIA 3 / FASCIA 4	€ 638,99	€ 702,89
PILETTA BASKET	€ 54,24	€ 54,24
SIFONE	€ 14,14	€ 14,14
<b>Totale Fascia 1/3/4</b>	<b>€ 707,38</b>	<b>€ 771,27</b>

# SINK COMPACT MOD. BREZZA INTERCAMBIABILE P. 210 mm

## FONDO PVD BRONZO O TITANIO - COSTRUITA IN HPL

### PER BASE 60

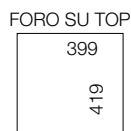
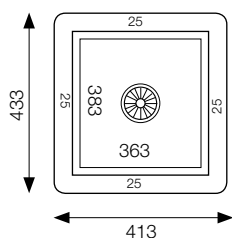

FASCIA 1	€	717,38
FASCIA 3 / FASCIA 4	€	717,38
PILETTA BASKET	€	54,24
SIFONE	€	14,14
<b>Totale Fascia 1/3/4</b>	€	<b>785,76</b>

### PER BASE 60

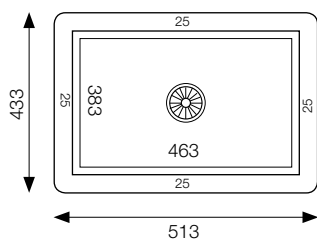

FASCIA 1	€	782,99
FASCIA 3 / FASCIA 4	€	782,99
PILETTA BASKET	€	54,24
SIFONE	€	14,14
<b>Totale Fascia 1/3/4</b>	€	<b>882,88</b>

### PER BASE 80 / 90

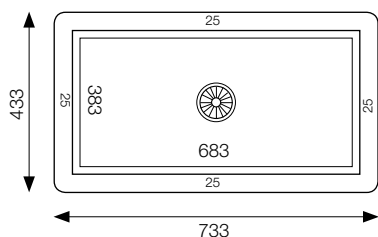

FASCIA 1	€	925,63
FASCIA 3 / FASCIA 4	€	925,63
PILETTA BASKET	€	54,24
SIFONE	€	14,14
<b>Totale Fascia 1/3/4</b>	€	<b>994,02</b>

# SINK COMPACT MOD. START INTERCAMBIABILE P. 210 mm

CON FORO RUBINETTO - FONDO PVD BRONZO O TITANIO - COSTRUITA IN HPL

## PER BASE 60

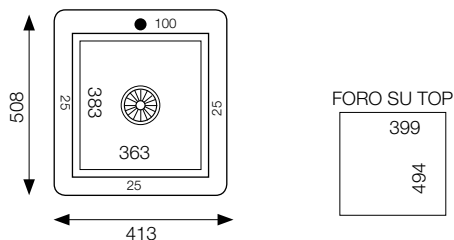

FASCIA 1	€	730,35
FASCIA 3 / FASCIA 4	€	730,35
PILETTA BASKET	€	54,24
SIFONE	€	14,14
<b>Totale Fascia 1/3/4</b>	€	<b>798,64</b>

## PER BASE 60

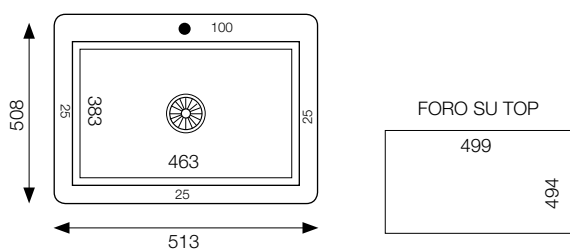

FASCIA 1	€	795,97
FASCIA 3 / FASCIA 4	€	795,97
PILETTA BASKET	€	54,24
SIFONE	€	14,14
<b>Totale Fascia 1/3/4</b>	€	<b>864,35</b>

## PER BASE 80 / 90

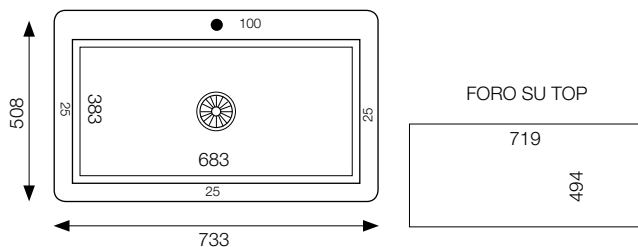

FASCIA 1	€	938,61
FASCIA 3 / FASCIA 4	€	938,61
PILETTA BASKET	€	54,24
SIFONE	€	14,14
<b>Totale Fascia 1/3/4</b>	€	<b>1.007,00</b>

# SINK COMPACT MOD. LINE INTERCAMBIABILE P. 210 mm

CON FORO RUBINETTO RIBASSATO - FONDO FILO INOX - COSTRUITA IN HPL  
 CON FORO RUBINETTO RIBASSATO - FONDO VINTAGE - COSTRUITA IN HPL

## PER BASE 60

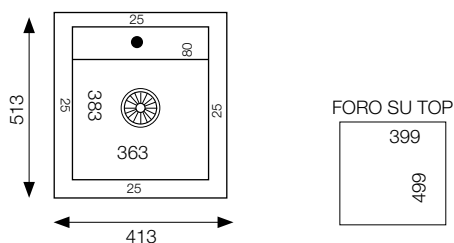

FONDO FILO INOX      FONDO VINTAGE

FASCIA 1	€ 701,60	€ 771,75
FASCIA 3 / FASCIA 4	€ 701,60	€ 771,75
PILETTA BASKET	€ 54,24	€ 54,24
SIFONE	€ 14,14	€ 14,14
<b>Totale Fascia 1/3/4</b>	<b>€ 769,98</b>	<b>€ 840,13</b>

## PER BASE 60

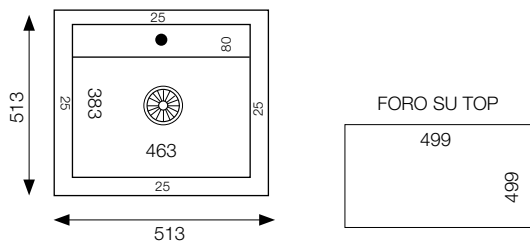

FONDO FILO INOX      FONDO VINTAGE

FASCIA 1	€ 738,14	€ 811,95
FASCIA 3 / FASCIA 4	€ 738,14	€ 811,95
PILETTA BASKET	€ 54,24	€ 54,24
SIFONE	€ 14,14	€ 14,14
<b>Totale Fascia 1/3/4</b>	<b>€ 825,42</b>	<b>€ 880,34</b>

## PER BASE 80 / 90

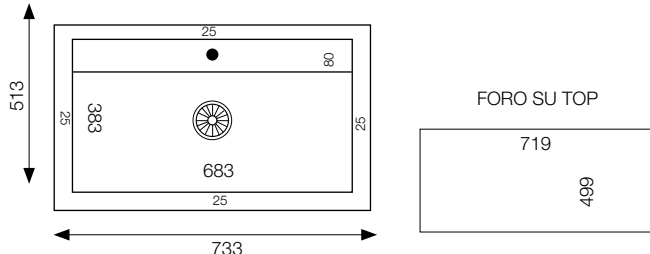

FONDO FILO INOX      FONDO VINTAGE

FASCIA 1	€ 855,42	€ 940,96
FASCIA 3 / FASCIA 4	€ 855,42	€ 940,96
PILETTA BASKET	€ 54,24	€ 54,24
SIFONE	€ 14,14	€ 14,14
<b>Totale Fascia 1/3/4</b>	<b>€ 923,81</b>	<b>€ 1.009,35</b>

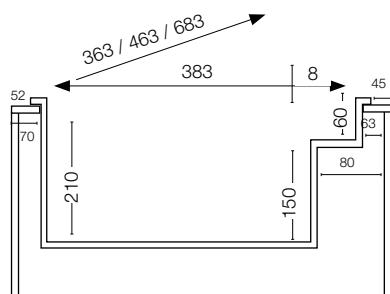

# SINK COMPACT MOD. SILVER INTERCAMBIABILE P. 210 mm

CON FORO RUBINETTO RIBASSATO - FONDO PVD BRONZO/TITANIO - COSTRUITA IN HPL

## PER BASE 60

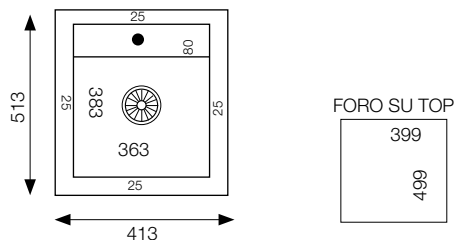

FASCIA 1	€	901,54
FASCIA 3 / FASCIA 4	€	901,54
PILETTA BASKET	€	54,24
SIFONE	€	14,14
<b>Totale Fascia 1/3/4</b>	€	<b>969,92</b>

## PER BASE 60

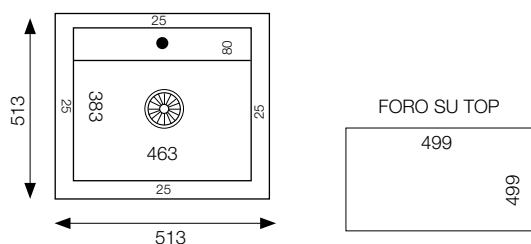

FASCIA 1	€	966,83
FASCIA 3 / FASCIA 4	€	966,83
PILETTA BASKET	€	54,24
SIFONE	€	14,14
<b>Totale Fascia 1/3/4</b>	€	<b>1.035,21</b>

## PER BASE 80 / 90

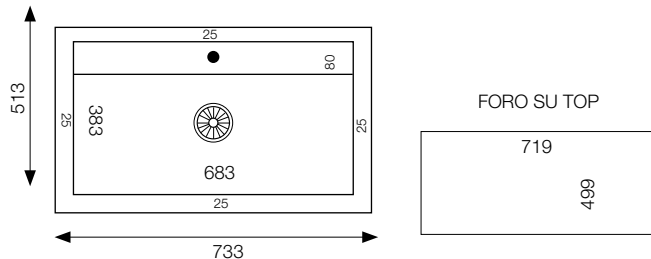

FASCIA 1	€	1.155,06
FASCIA 3 / FASCIA 4	€	1.155,06
PILETTA BASKET	€	54,24
SIFONE	€	14,14
<b>Totale Fascia 1/3/4</b>	€	<b>1.223,42</b>

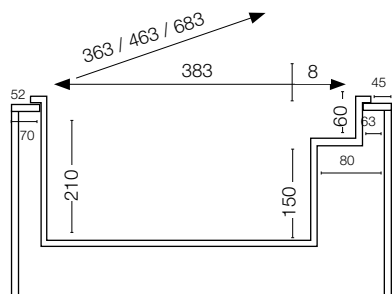

# SINK COMPACT MOD. VENTO SCIVOLO INTERCAMBIABILE P. 210 mm

## CON SGOCCIOLATOIO FONDO HPL - COSTRUITA IN HPL

### PER BASE 80

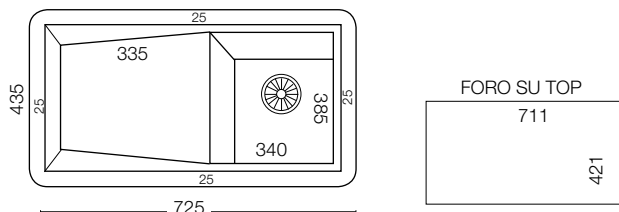

FASCIA 1	€	842,01
PILETTA BASKET	€	54,24
SIFONE	€	14,14
<b>Totale</b>	€	<b>910,40</b>

### PER BASE 90

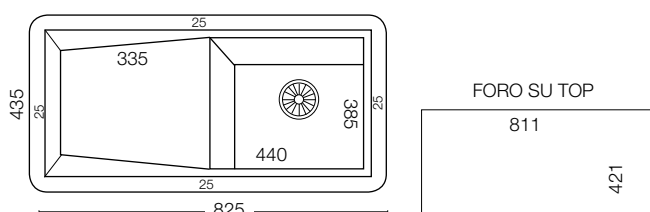

FASCIA 1	€	866,04
PILETTA BASKET	€	54,24
SIFONE	€	14,14
<b>Totale</b>	€	<b>934,42</b>

### PER BASE 90

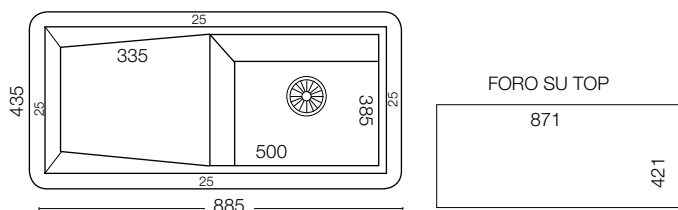

FASCIA 1	€	920,64
PILETTA BASKET	€	54,24
SIFONE	€	14,14
<b>Totale</b>	€	<b>989,02</b>

### PER BASE 120

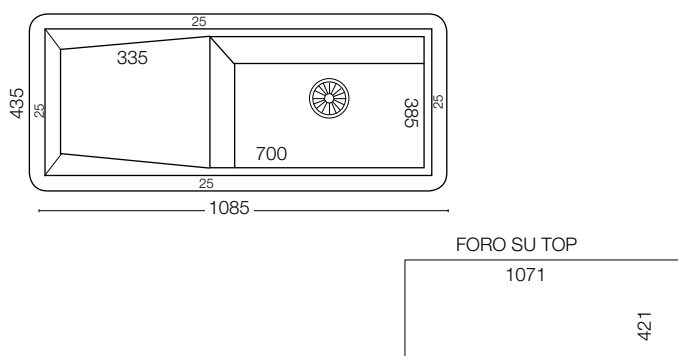

FASCIA 1	€	975,24
PILETTA BASKET	€	54,24
SIFONE	€	14,14
<b>Totale</b>	€	<b>1.043,62</b>

# SINK COMPACT MOD. SLITTA SCIVOLO INTERCAMBIABILE P. 210 mm

CON FORO RUBINETTO E CON SGOCCIOLATOIO FONDO HPL - COSTRUITA IN HPL

PER BASE 80

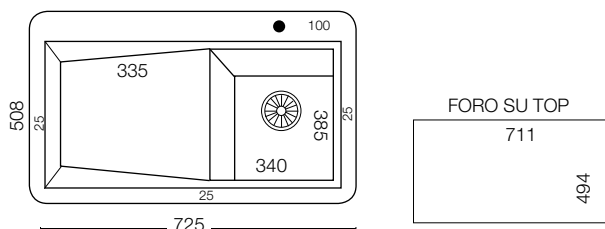

FASCIA 1	€	854,99
PILETTA BASKET	€	54,24
SIFONE	€	14,14
<b>Totale</b>	€	<b>874,03</b>

PER BASE 90

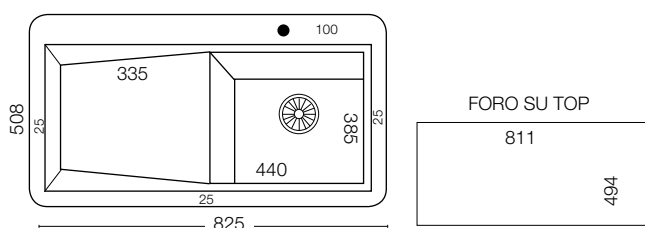

FASCIA 1	€	879,01
PILETTA BASKET	€	54,24
SIFONE	€	14,14
<b>Totale</b>	€	<b>947,40</b>

PER BASE 90

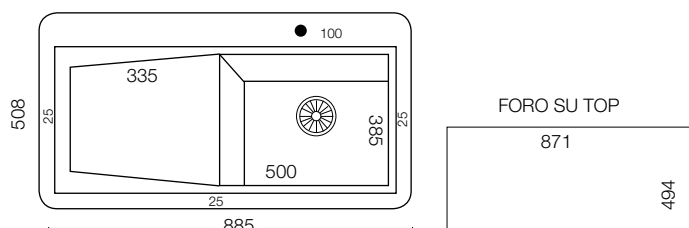

FASCIA 1	€	933,61
PILETTA BASKET	€	54,24
SIFONE	€	14,14
<b>Totale</b>	€	<b>1.002,00</b>

PER BASE 120

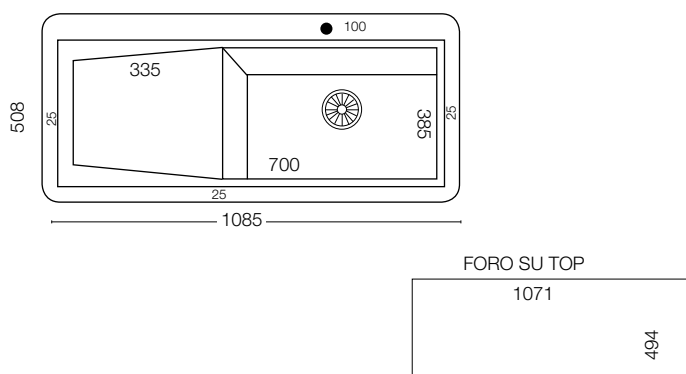

FASCIA 1	€	988,21
PILETTA BASKET	€	54,24
SIFONE	€	14,14
<b>Totale</b>	€	<b>1.056,60</b>



# SINK COMPACT MOD. FONTANA SCIVOLO INTERCAMBIABILE P. 210 mm

**FONDO FILO INOX - COSTRUITA IN HPL**  
**FONDO VINTAGE - COSTRUITA IN HPL**

## PER BASE 80

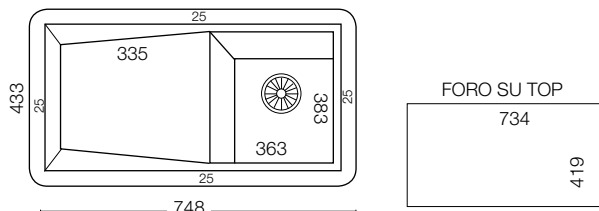

	FONDO FILO INOX	FONDO VINTAGE
FASCIA 1	€ 842,01	€ 926,22
FASCIA 3 / FASCIA 4	€ 842,01	€ 926,22
PILETTA BASKET	€ 54,24	€ 54,24
SIFONE	€ 14,14	€ 14,14
<b>Totale Fascia 1/3/4</b>	<b>€ 910,40</b>	<b>€ 994,61</b>

## PER BASE 90

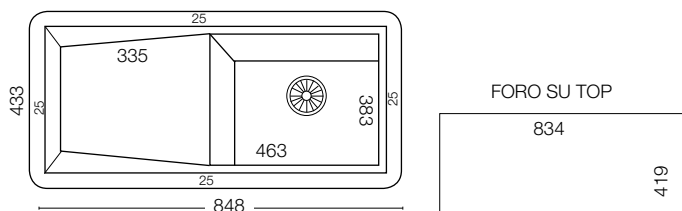

	FONDO FILO INOX	FONDO VINTAGE
FASCIA 1	€ 866,04	€ 952,64
FASCIA 3 / FASCIA 4	€ 866,04	€ 952,64
PILETTA BASKET	€ 54,24	€ 54,24
SIFONE	€ 14,14	€ 14,14
<b>Totale Fascia 1/3/4</b>	<b>€ 934,42</b>	<b>€ 916,03</b>

## PER BASE 120

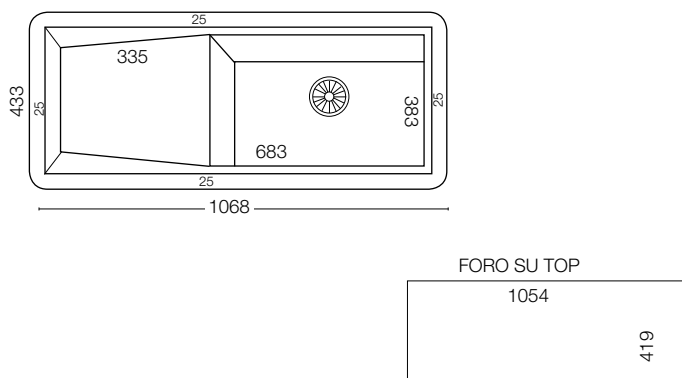

	FONDO FILO INOX	FONDO VINTAGE
FASCIA 1	€ 975,24	€ 1.072,64
FASCIA 3 / FASCIA 4	€ 975,24	€ 1.072,64
PILETTA BASKET	€ 54,24	€ 54,24
SIFONE	€ 14,14	€ 14,14
<b>Totale Fascia 1/3/4</b>	<b>€ 1.043,62</b>	<b>€ 1.141,15</b>

# SINK COMPACT MOD. FUGGI SCIVOLO INTERCAMBIABILE P. 210 mm

CON FORO RUBINETTO E FONDO FILO INOX - COSTRUITA IN HPL  
 CON FORO RUBINETTO E FONDO VINTAGE - COSTRUITA IN HPL

## PER BASE 80

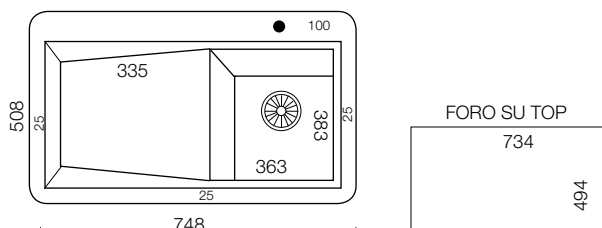

	FONDO FILO INOX	FONDO VINTAGE
FASCIA 1	€ 854,99	€ 940,49
FASCIA 3 / FASCIA 4	€ 854,99	€ 940,49
PILETTA BASKET	€ 54,24	€ 54,24
SIFONE	€ 14,14	€ 14,14
<b>Totale Fascia 1/3/4</b>	<b>€ 923,38</b>	<b>€1.008,88</b>

## PER BASE 90

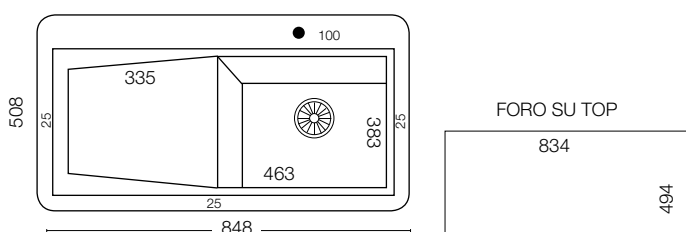

	FONDO FILO INOX	FONDO VINTAGE
FASCIA 1	€ 879,01	€ 966,92
FASCIA 3 / FASCIA 4	€ 879,01	€ 966,92
PILETTA BASKET	€ 54,24	€ 54,24
SIFONE	€ 14,14	€ 14,14
<b>Totale Fascia 1/3/4</b>	<b>€ 947,40</b>	<b>€1.035,31</b>

## PER BASE 120

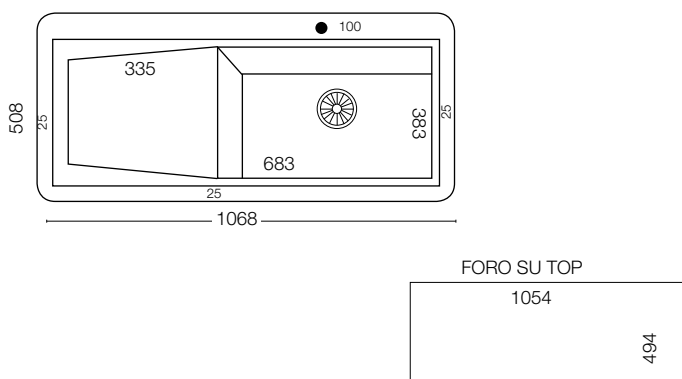

	FONDO FILO INOX	FONDO VINTAGE
FASCIA 1	€ 988,21	€ 1.087,04
FASCIA 3 / FASCIA 4	€ 988,21	€ 1.087,04
PILETTA BASKET	€ 54,24	€ 54,24
SIFONE	€ 14,14	€ 14,14
<b>Totale Fascia 1/3/4</b>	<b>€ 1.056,60</b>	<b>€1.155,43</b>

# SINK COMPACT MOD. PIAZZA SCIVOLO INTERCAMBIABILE P. 210 mm

## FONDO PVD BRONZO O TITANIO SPAZZOLATO - COSTRUITA IN HPL

### PER BASE 80

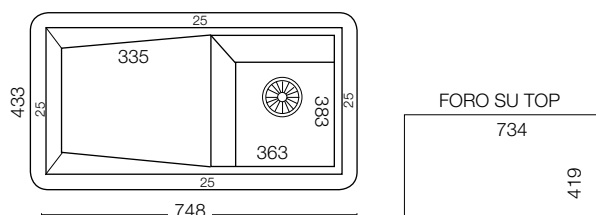

FASCIA 1	€	985,03
FASCIA 3/ FASCIA 4	€	985,03
PILETTA BASKET	€	54,24
SIFONE	€	14,14
<b>Totale Fascia 1/3/4</b>	<b>€</b>	<b>1.053,42</b>

### PER BASE 90

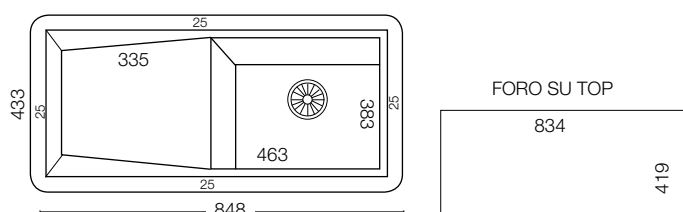

FASCIA 1	€	1.037,72
FASCIA 3/ FASCIA 4	€	1.037,72
PILETTA BASKET	€	54,24
SIFONE	€	14,14
<b>Totale Fascia 1/3/4</b>	<b>€</b>	<b>1.106,11</b>

### PER BASE 120

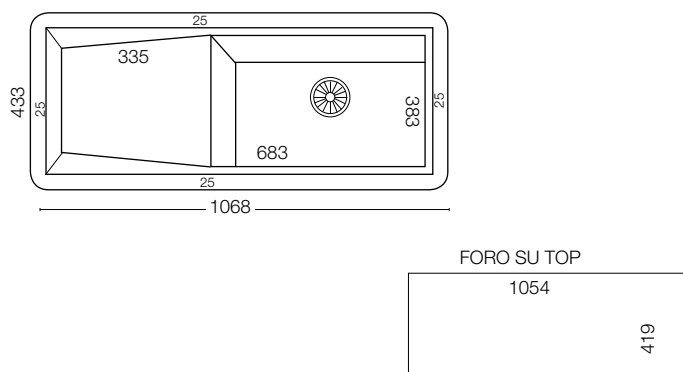

FASCIA 1	€	1.217,86
FASCIA 3/ FASCIA 4	€	1.217,86
PILETTA BASKET	€	54,24
SIFONE	€	14,14
<b>Totale Fascia 1/3/4</b>	<b>€</b>	<b>1.286,25</b>

# SINK COMPACT MOD. ARTE SCIVOLO INTERCAMBIABILE P. 210 mm

CON FORO RUBINETTO E FONDO PVD BRONZO O TITANIO - COSTRUITA IN HPL

## PER BASE 80

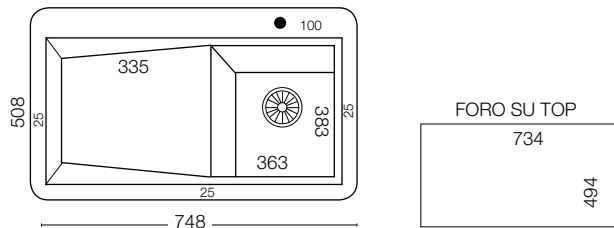

FASCIA 1	€	998,01
FASCIA 3/ FASCIA 4	€	998,01
PILETTA BASKET	€	54,24
SIFONE	€	14,14
<b>Totale Fascia 1/3/4</b>	€	<b>1.066,40</b>

## PER BASE 90

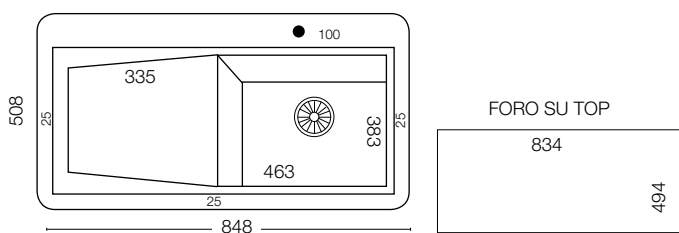

FASCIA 1	€	1.050,70
FASCIA 3/ FASCIA 4	€	1.050,70
PILETTA BASKET	€	54,24
SIFONE	€	14,14
<b>Totale Fascia 1/3/4</b>	€	<b>1.119,09</b>

## PER BASE 120

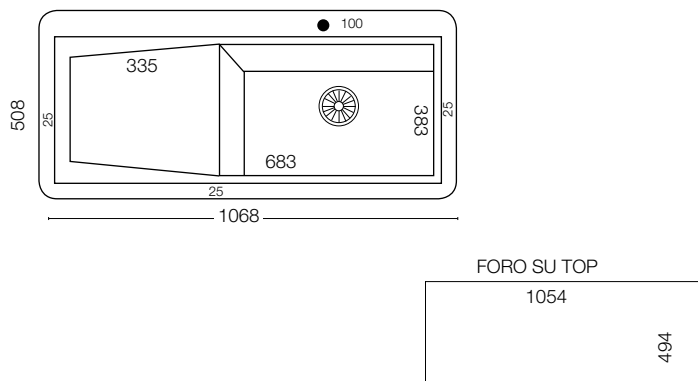

FASCIA 1	€	1.230,84
FASCIA 3/ FASCIA 4	€	1.280,84
PILETTA BASKET	€	54,24
SIFONE	€	14,14
<b>Totale Fascia 1/3/4</b>	€	<b>1.299,22</b>

# SINK COMPACT MOD. RIBA SCIVOLO INTERCAMBIABILE P. 210 mm

CON FORO RUBINETTO RIBASSATO E FONDO FILO INOX - COSTRUITA IN HPL  
 CON FORO RUBINETTO RIBASSATO E FONDO VINTAGE - COSTRUITA IN HPL

## PER BASE 80

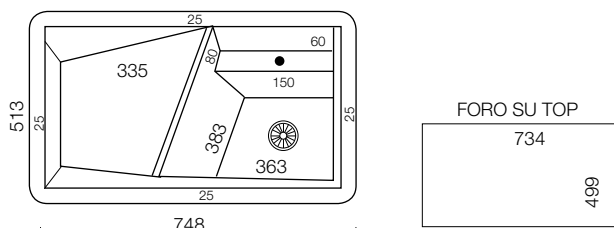

	FONDO FILO INOX	FONDO VINTAGE
FASCIA 1	€ 1.036,74	€ 1.140,41
FASCIA 3 / FASCIA 4	€ 1.036,74	€ 1.140,41
PILETTA BASKET	€ 54,24	€ 52,24
SIFONE	€ 14,14	€ 14,14
<b>Totale Fascia 1/3/4</b>	<b>€ 1.095,68</b>	<b>€ 1.208,80</b>

## PER BASE 90

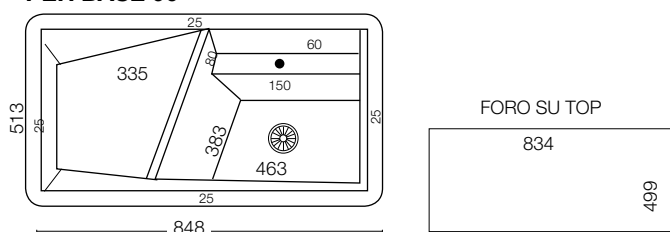

	FONDO FILO INOX	FONDO VINTAGE
FASCIA 1	€ 1.049,87	€ 1.154,85
FASCIA 3 / FASCIA 4	€ 1.049,87	€ 1.154,85
PILETTA BASKET	€ 52,24	€ 52,24
SIFONE	€ 14,14	€ 14,14
<b>Totale Fascia 1/3/4</b>	<b>€ 1.118,26</b>	<b>€ 1.223,24</b>

## PER BASE 120

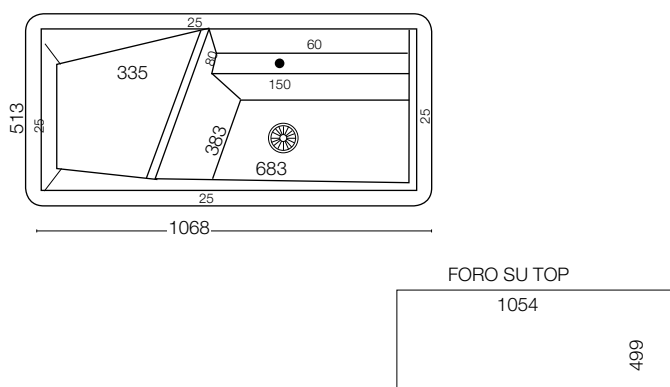

	FONDO FILO INOX	FONDO VINTAGE
FASCIA 1	€ 1.205,27	€ 1.325,79
FASCIA 3 / FASCIA 4	€ 1.205,27	€ 1.325,79
PILETTA BASKET	€ 52,24	€ 52,24
SIFONE	€ 14,14	€ 14,14
<b>Totale Fascia 1/3/4</b>	<b>€ 1.273,66</b>	<b>€ 1.394,18</b>

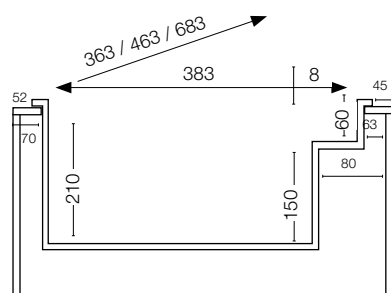

# SINK COMPACT MOD. LUNA SCIVOLO INTERCAMBIABILE P. 210 mm

CON FORO RUBINETTO RIBASSATO E FONDO PVD BRONZO/TITANIO - COSTRUITA IN HPL

## PER BASE 80

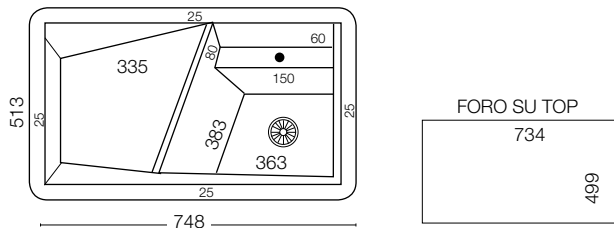

FASCIA 1	€	1.170,32
FASCIA 3/ FASCIA 4	€	1.170,32
PILETTA BASKET	€	54,24
SIFONE	€	14,14
<b>Totale Fascia 1/3/4</b>	€	<b>1.1238,70</b>

## PER BASE 90

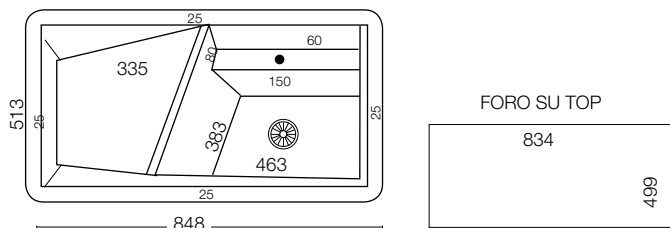

FASCIA 1	€	1.221,27
FASCIA 3/ FASCIA 4	€	1.221,27
PILETTA BASKET	€	54,24
SIFONE	€	14,14
<b>Totale Fascia 1/3/4</b>	€	<b>1.289,66</b>

## PER BASE 120

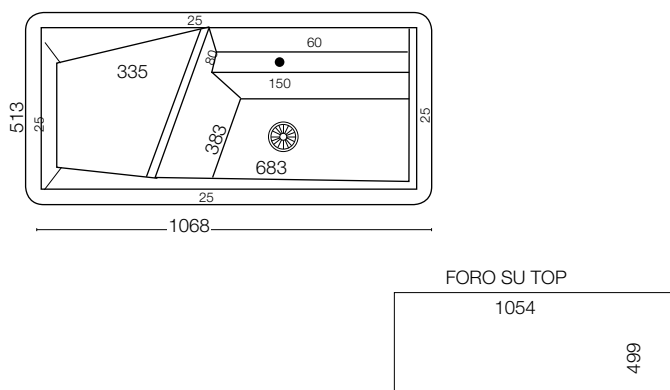

FASCIA 1	€	1.447,89
FASCIA 3/ FASCIA 4	€	1.447,89
PILETTA BASKET	€	54,24
SIFONE	€	14,14
<b>Totale Fascia 1/3/4</b>	€	<b>1.516,28</b>

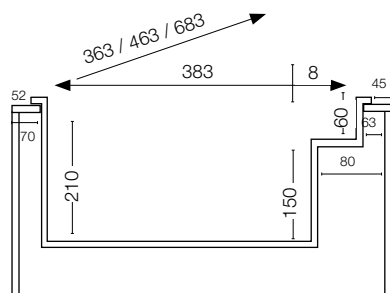

## SGOCCIOLATOIO E TAGLIERE COPRIVASCA SCORREVOLE

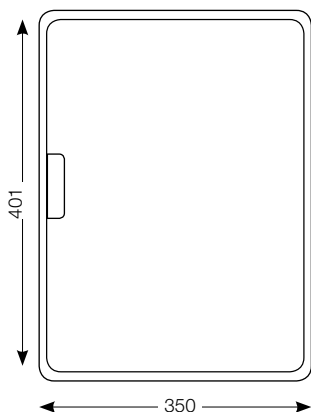
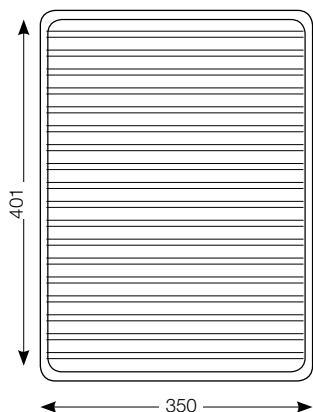

Per modelli:

SIMPLI  
SINTONIA  
IDEAL  
STOP  
BREZZA  
START  
VENTO SCIVOLO  
SLITTASCIVOLO  
FONTANA SCIVOLO  
FUGGI SCIVOLO  
PIAZZA SCIVOLO  
ARTE SCIVOLO

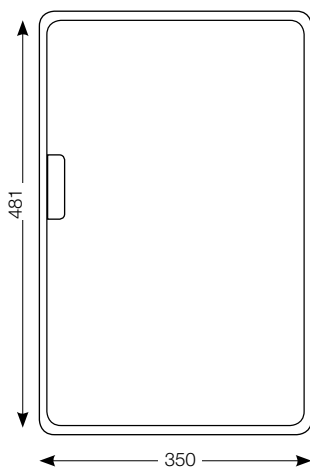
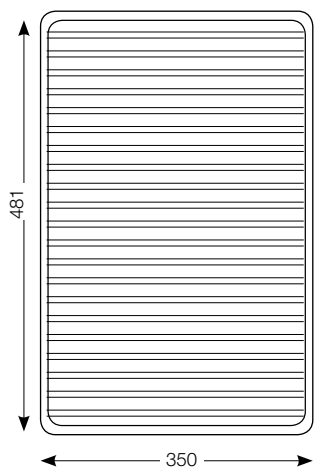

Per modelli:

LINE  
RIBA SCIVOLO

SGOCCIOLATOIO E TAGLIERE COPRIVASCA SCORREVOLE  
FASCIA 1/3/4 € 157,24 CAD.

## **SOMMARIO CATEGORIE**

6 LAVELLI



## **ATTENZIONE**

Le vasche integrate con fondo in HPL rappresentano un importante valore aggiunto dal punto di vista estetico e commerciale e vengono singolarmente testate al momento della produzione, ma, per il materiale utilizzato, necessitano di qualche piccola attenzione in più per il loro corretto mantenimento in special modo relativamente al fondo della vasca. Si consiglia pertanto:

- di asciugare sempre il fondo della vasca dopo l'utilizzo per non lasciare ristagni
- di non sversare, in nessun caso, olii bollenti o altri liquidi corrosivi o ad alte temperature
- di pulire regolarmente il fondo della vasca secondo le istruzioni riportate per evitare ingiallimenti, alonature e/o scolorimenti dovuti al depositarsi di un velo di calcare
- di aprire l'acqua fredda prima di scolare liquidi caldi (acqua di cottura)
- di non usare assolutamente sostanze abrasive o graffianti, decalcificanti o pulitori per scarichi, detersivi per forno o per metalli.
- di utilizzare, per la normale pulizia, detersivi neutri o comune detersivo per piatti
- di trattare la vasca con spray ai siliconi per mobili per favorire il deflusso dell'acqua e evitare la sedimentazione di sporco e calcare (vedi istruzioni di manutenzione)

Eventuali danni che dovessero intervenire saranno esclusivamente sanati con il montaggio di un fondo inox all'interno della medesima vasca.

## **ATTENZIONE**

L'assemblaggio delle vasche integrate al piano è certificato e garantito per il normale utilizzo, ma può essere compromesso da forti urti nel corso del trasporto, della movimentazione e dello stoccaggio in attesa del definitivo montaggio presso il cliente.

Occorre dunque prestare la massima attenzione e verificare l'integrità della vasca ed il relativo assemblaggio al top al momento dello scarico al fine di segnalare eventuali difettosità nella consegna da parte dell'azienda.

Eventuali successive contestazioni relativamente a quanto sopra non potranno essere accettate.





# **GIERREDUE**

surfaces | design

**Gierredue Arredamenti srl**  
**Loc. Pian dell'Olmino, 80**  
**53034 Colle Val d'Elsa (SI)**  
**Italia**  
**C.F. / P.IVA 01111180525**

**+39 0577 908217**  
**info@gr2arredamenti.it**

**gr2arredamenti.it**